

EVK Operating SOP

Demo Kit Hardware Description

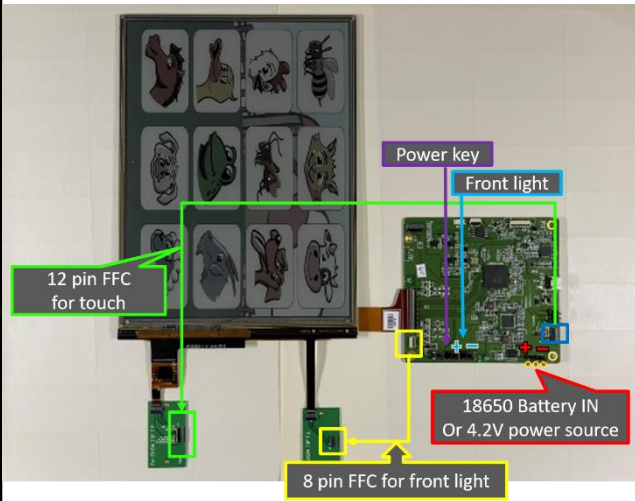

Connector	Function
4.2V DC inrout	DC 4.2V, for TCON power supply
45P FFC CONNECTOR	Connector to 7.8 inch Kaleido plus color EPD bridge board
12P Touch FFC	Connect to touch panel
8P front light FFC	Connect to front light connector

Operating Instructions

① Connect to Physical

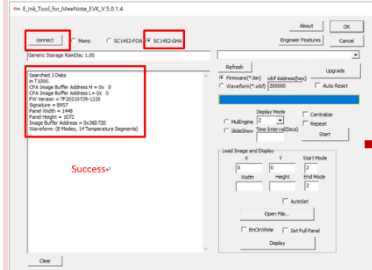

Notice: Press power key on EVK before connect NB

② Load image to T1000

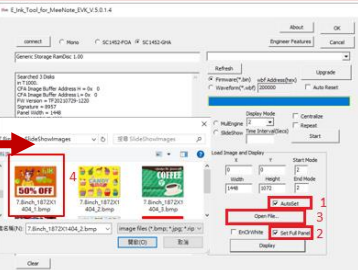

- 1) Select "AutoSet".
- 2) Select "Set Full Panel".
- 3) 4) Click "Open File.." to load the image.

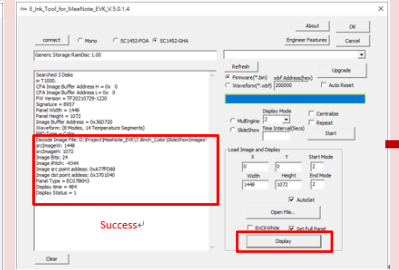

- 5) Click Display
- 6) Success load the image

Single Image Mode

③ Display the image

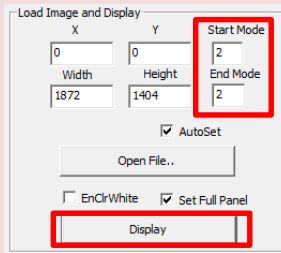

click "Display"

Slide Show Mode

③ Run slideshow

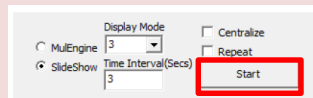

click "Start"

Engineer Features Description

Set/Get VCOM

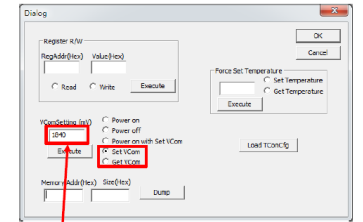

-1.84

Vcom values are marked on the PCB label